

基于MATLAB平台的移动宽带系统设计与验证

MathWorks CHINA EXPO 2017

朱尔霓
华为技术专家

www.huawei.com

演讲者

- **朱尔霓**

无线数字前端算法技术专家，华为技术有限公司

2000年毕业于东南大学，就职于华为技术有限公司，一直从事无线数字前端相关的算法研究与开发工作。



目录

- **无线通信网络的演进与挑战**
- 模拟数字混合系统建模与分析
- 软硬件系统验证
- 加速工程实现

无线通信的基础理论与工程化

1. $\nabla \cdot \mathbf{D} = \rho_v$
 2. $\nabla \cdot \mathbf{B} = 0$
 3. $\nabla \times \mathbf{E} = -\frac{\partial \mathbf{B}}{\partial t}$
 4. $\nabla \times \mathbf{H} = \frac{\partial \mathbf{D}}{\partial t} + \mathbf{J}$
- @1865年

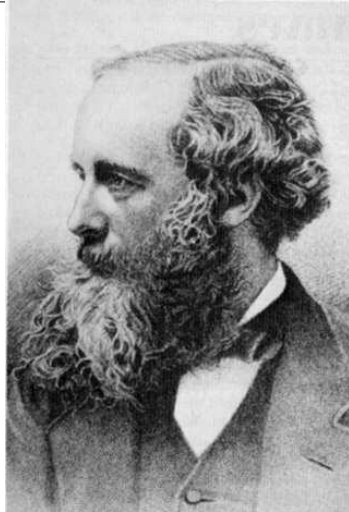

Maxwell

1888年, Hertz通过实验证明了Maxwell电磁理论从此开创了无线电电子技术的新纪元



Shannon

$$C = B \log_2 \left(1 + \frac{S}{N} \right)$$

A mathematical theory of communication
@1948年

1947年, 贝尔实验室的肖克利、巴丁和布拉顿组成的研究小组, 研制出一种点接触型的锗晶体管, 引发了电子行业的革命。

无线通信的历史回顾

1897	1904	1921	1947	1948	1949	1958	1970~	1980 年代中 期	1991	1995	2001	2010	2015	2020
第一个 无线电 传输 马可尼	真空管 佛来明	美国底特 律市警察 使用的车 载无线电 系统。该 系统工作 频率为 2MHz	晶体管， 贝尔实验 室的 W. Schockle y	信息论 Shann on	传呼机 美国人 Al Gross	集成电路 Jack Kilby； 1961 INTEL Robert Noyce	贝尔实验 室（蜂窝 概念， AMPS实 验）	GSM研 究	2G 商用 GSM ，地点 是芬兰 的 Radiol inja。	第一个 商用 CDMA	3G WCDM A CDMA TD- SCDM A	4G TeliaSo nera 第 一个商 用。设 备分别 由爱立 信和华 为提供。	4.5G 华为首 提4.5G 概念， 华为与 TeliaSo nera携 手在挪 威奥斯 陆4.5G 全球首 发	5G eMBB mMTC urLLC

从1G到5G

1G

1981

AMPS

- Analog
- 2.4kbps
- Voice only
- Cells

2G

1992

GSM

- Digital Standard
- 9.6kbps~384kbps
- Design for Voice
- Basic data service

3G

2001

WCDMA

- 14.4Mbps~100Mbps+
- Design for Voice with data service

4G

2007

LTE

- 150Mbps~1Gbps
- Design for data
- MBB

5G

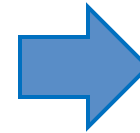

Usage scenarios of IMT for 2020 and beyond
Enhanced mobile broadband

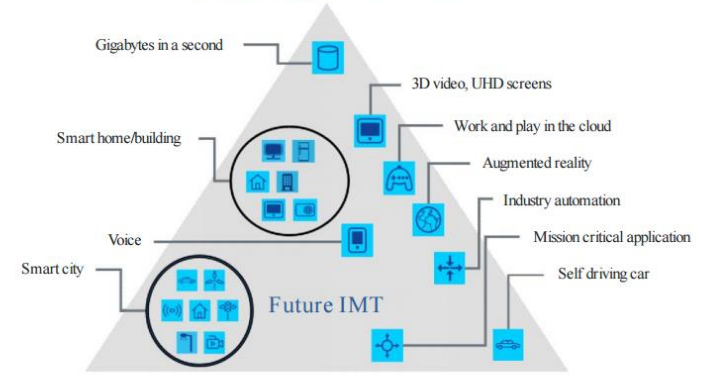

Massive machine type communications

Ultra-reliable and low latency communications

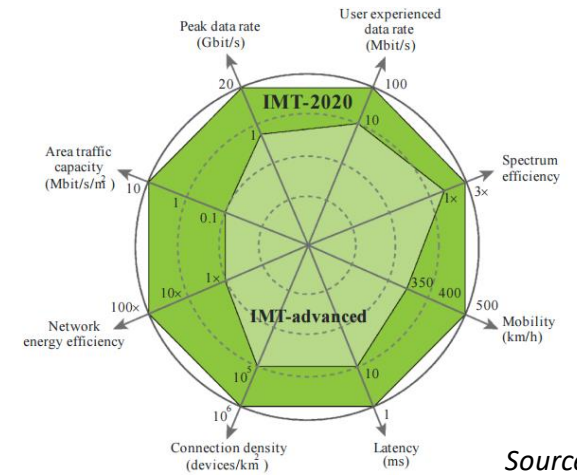

Source: ITU-R M.2083-0

中射频子系统与关键指标

1. $\nabla \cdot \mathbf{D} = \rho_v$
2. $\nabla \cdot \mathbf{B} = 0$
3. $\nabla \times \mathbf{E} = -\frac{\partial \mathbf{B}}{\partial t}$
4. $\nabla \times \mathbf{H} = \frac{\partial \mathbf{D}}{\partial t} + \mathbf{J}$

$$C \approx B \cdot n \cdot \log 2 \left(1 + \frac{S}{N} \right)$$

容量 带宽 多天线 信噪比

Transceiver/Power Amplifier/Antenna

Power/Noise/Linearity ...

Bandwidth

Integration/Cost/Green

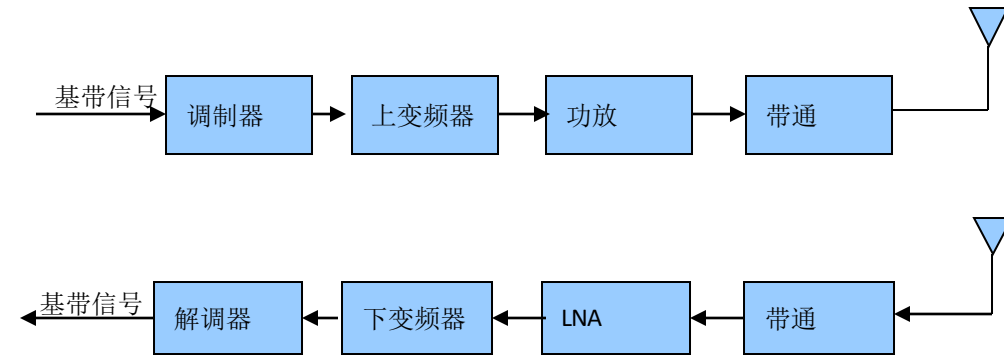

软件无线电的趋势

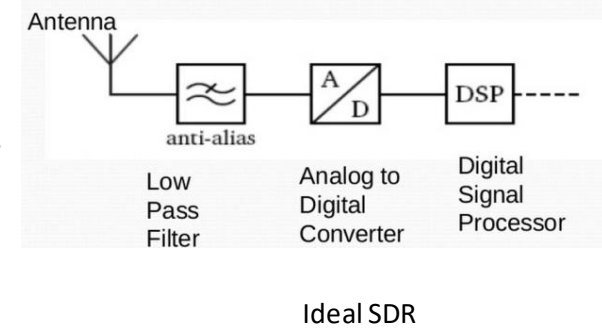
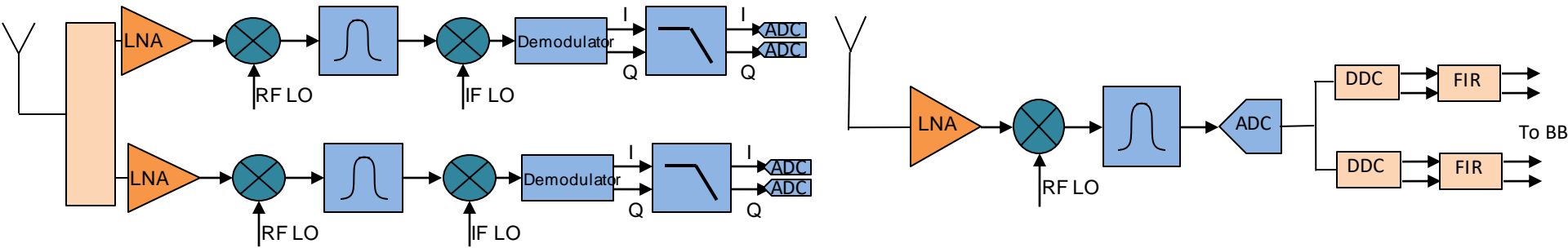

Software Radio:

- Perfect
- Programmable
- Cost and area reduction
- Use techniques which analog can't do
- Multi-mode, Multi-standard, Multi-carrier

Moore laws vs Non-Moore laws:

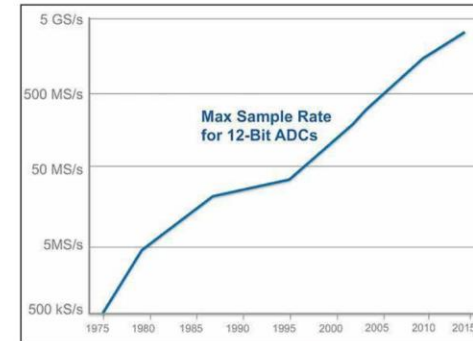

Figure 1 • Maximum sample rate for 12-bit ADCs has grown exponentially since 1975.

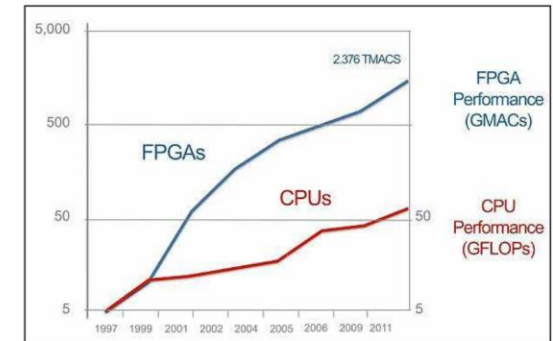

Figure 2 • The performance increases of FPGAs and CPUs is analogous to Moore's law.

1.1kg → 0.1kg

目录

- 无线通信网络的演进与挑战
- **模拟数字混合系统建模与分析**
- 软硬件系统验证
- 加速工程实现

中射频系统：数字模拟混合系统

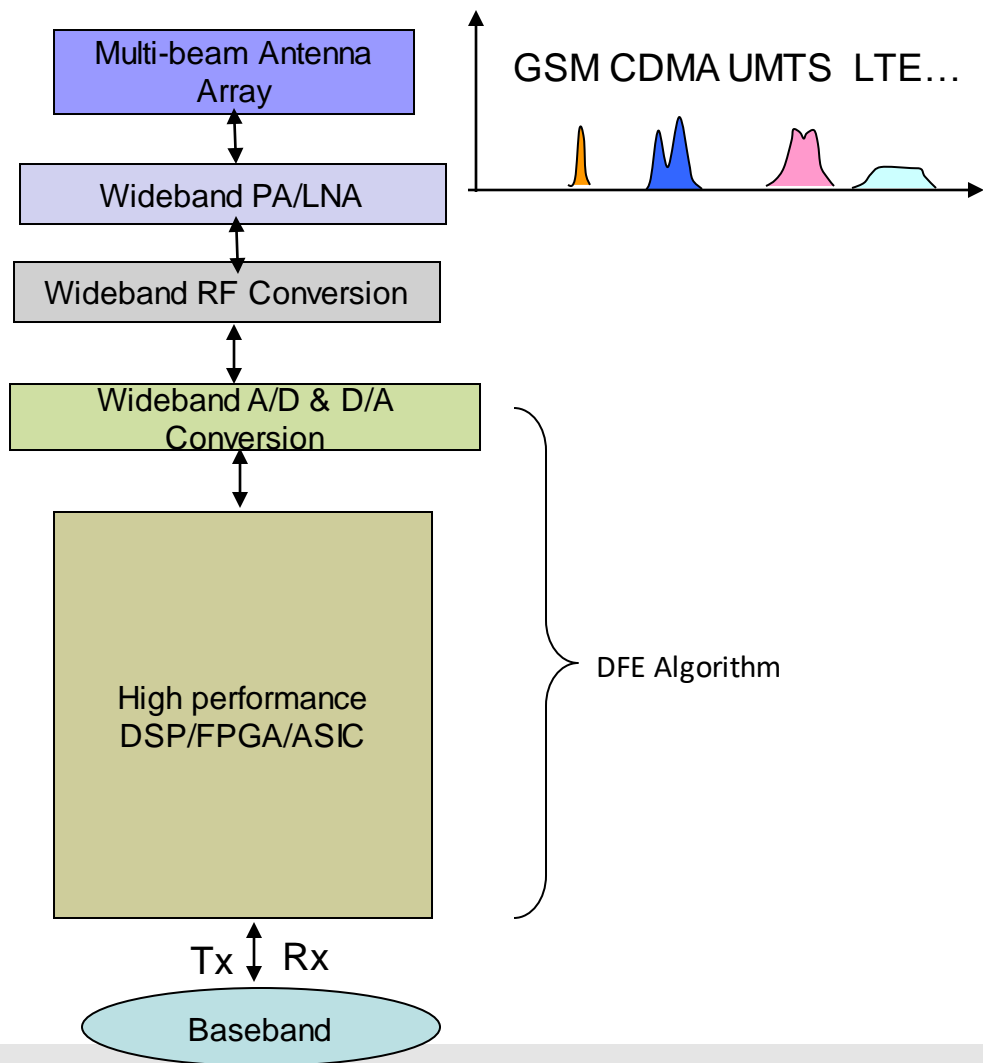

➤ 发展方向

数字处理更加靠近天线

宽带、多频段、多制式、开放性、灵活性

➤ 发展基础

器件制造工艺水平的进步

数字信号处理算法

数字模拟混合建模的例子-DPD算法

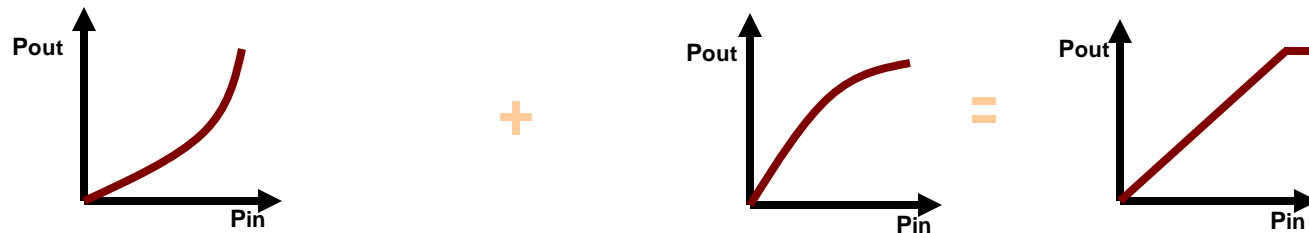
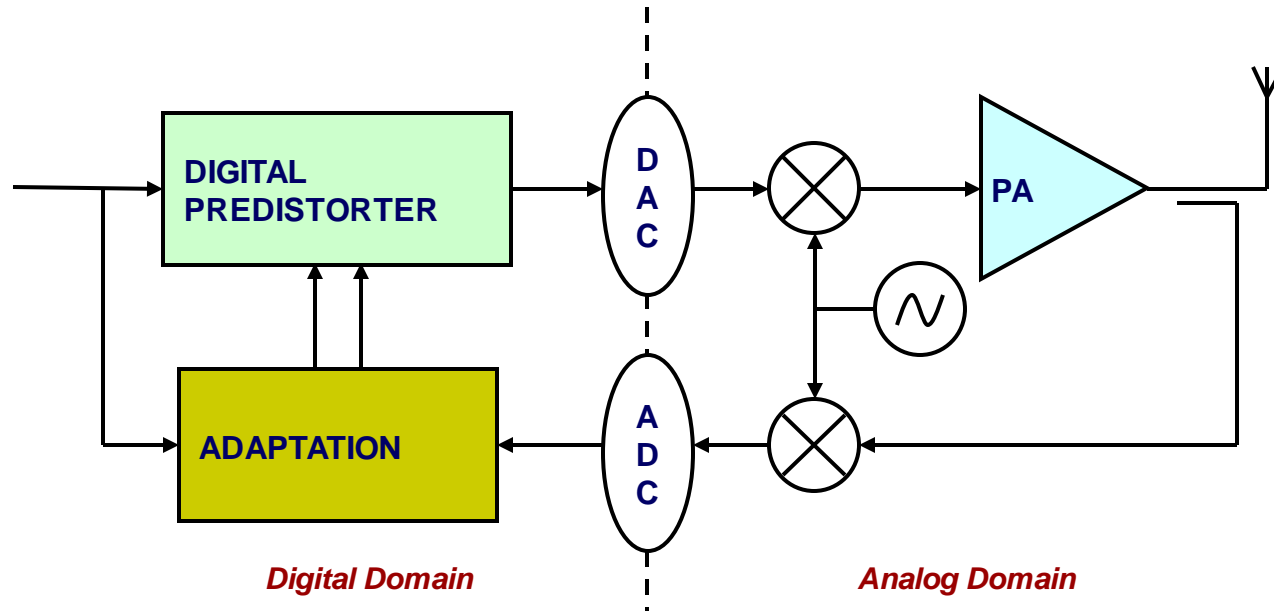

行为建模 vs 物理建模

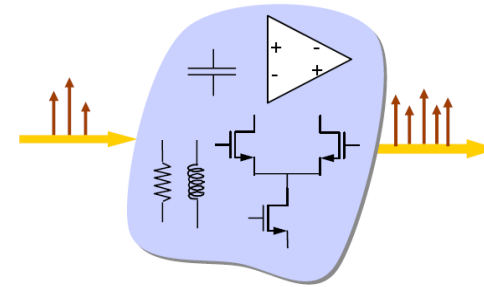
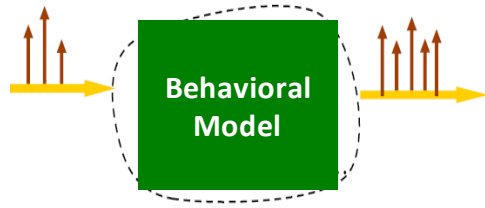

行为建模

- 黑盒模型，基于假设与数据测量，没有物理意义
- 依赖于输入输出数据的观察和分析
- 基于数学的理论与公式 $y(t)=F[x(t)]$

$$\tilde{y}(n) = \sum_{k=0}^{P-1} \sum_{i=0}^M a_{2k+1,i} |\tilde{x}(n-i)|^{2k} \tilde{x}(n-i)$$

物理建模

- 电路模型，有物理意义。
- 每个参数及变量可具体分析。
- 精度有限，计算复杂度高

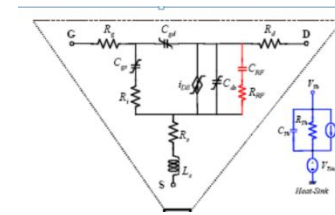

实例：基于MATLAB and Simulink的DPD混合仿真

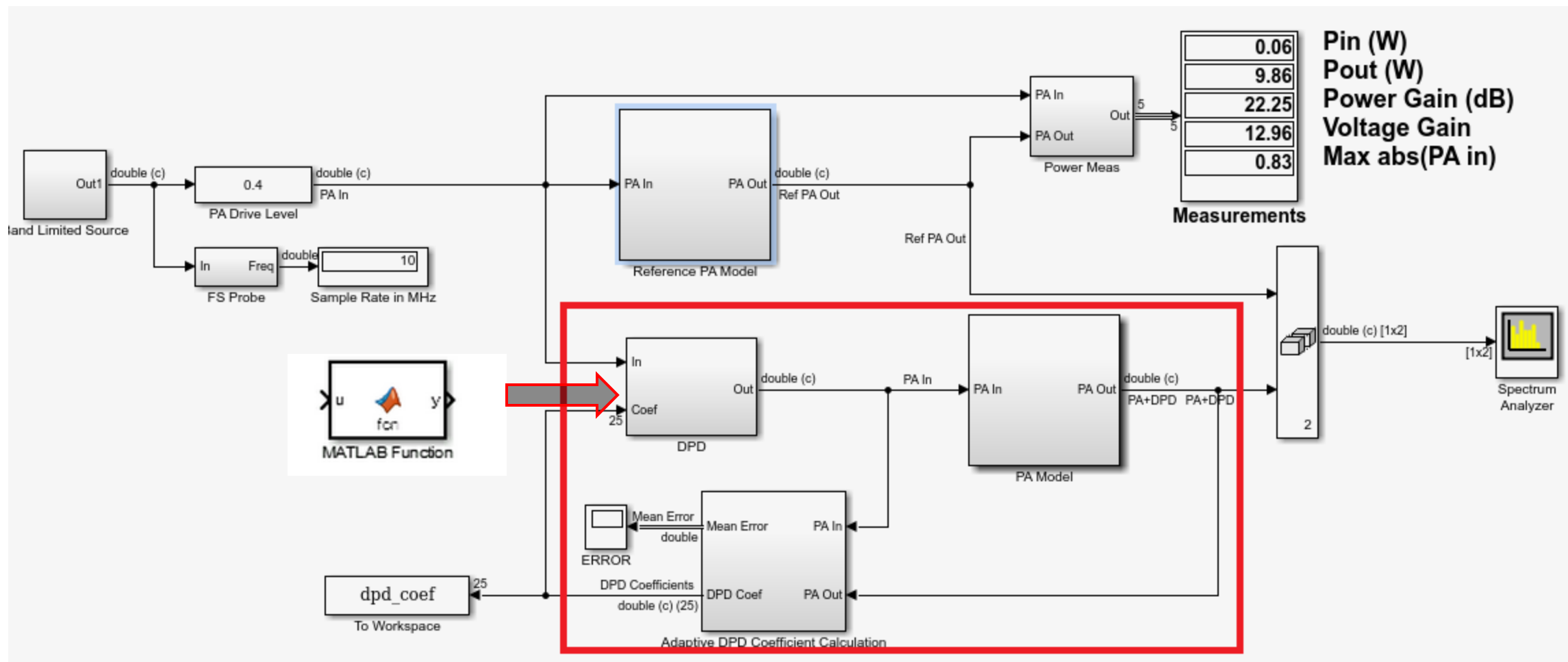

PD混合仿真

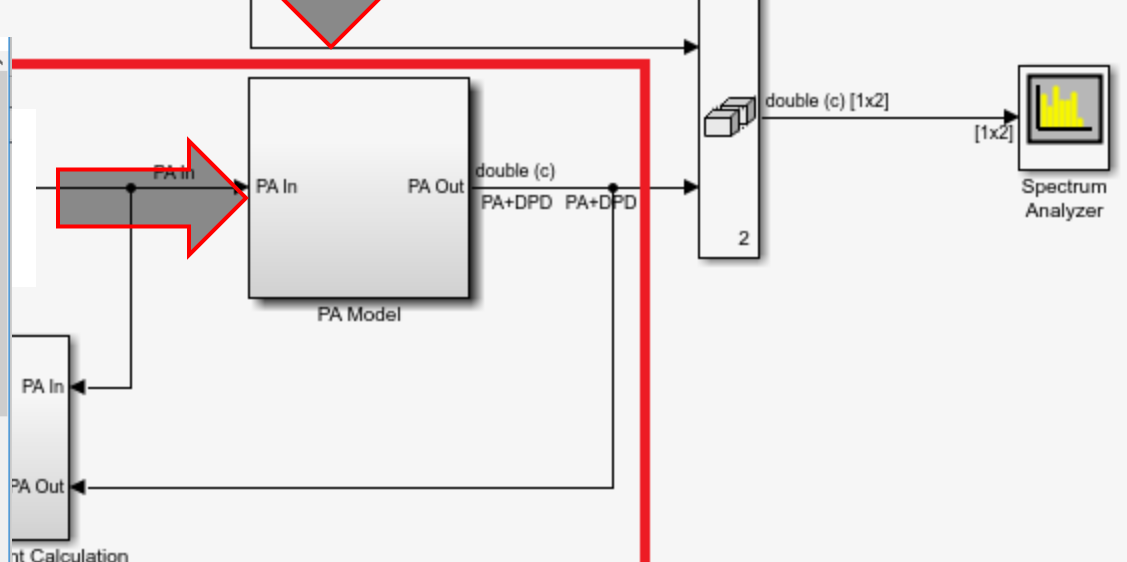
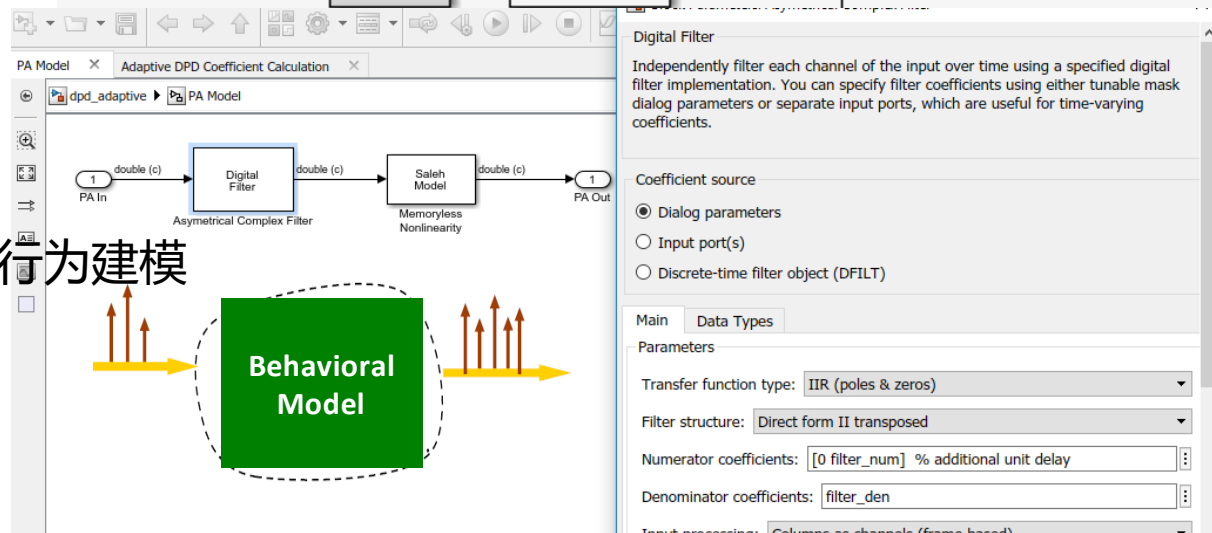
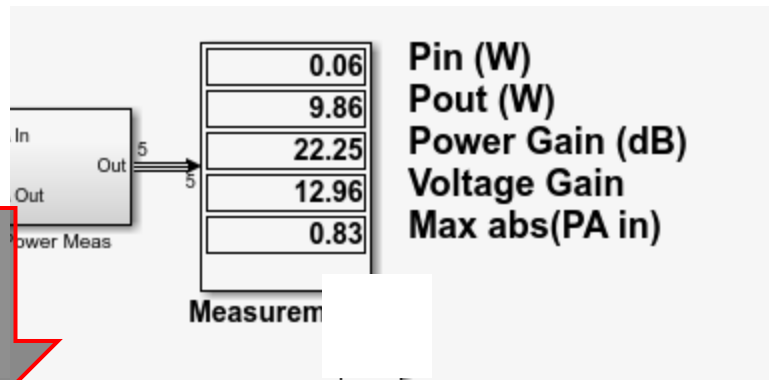
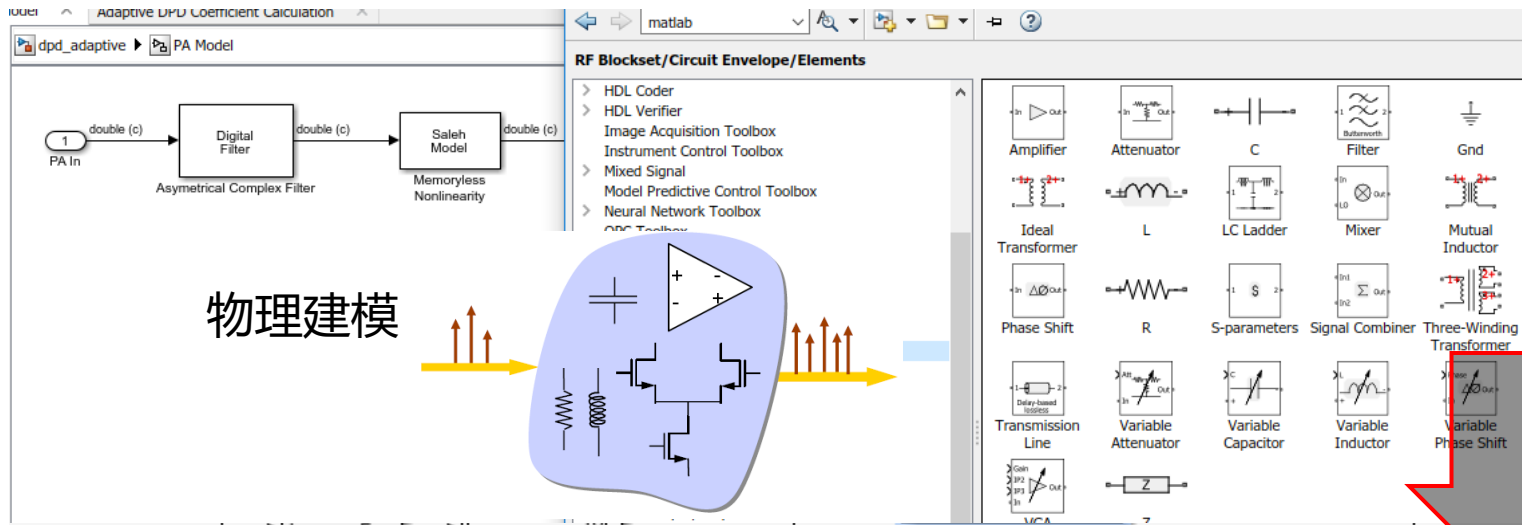

基于MATLAB and Simulink的DPD仿真

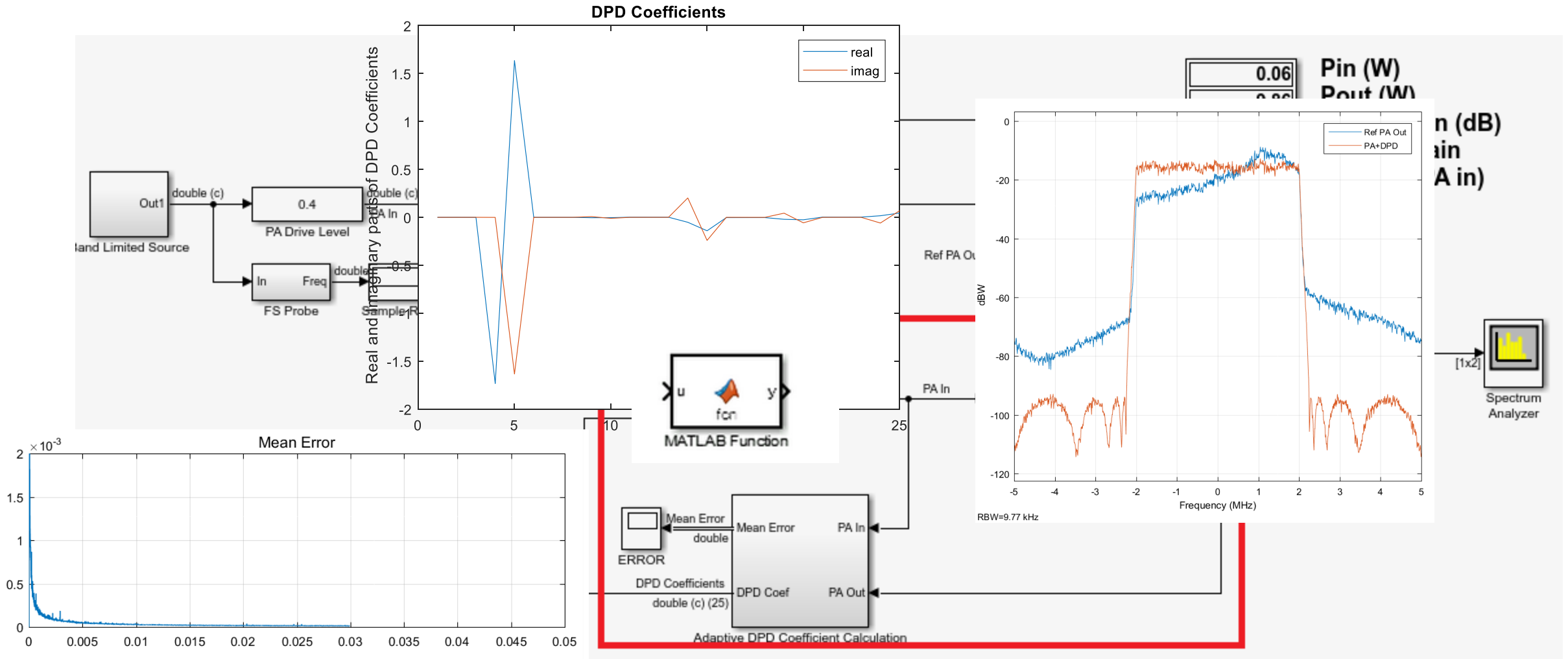

目录

- 无线通信网络的演进与挑战
- 模拟数字混合系统建模与分析
- **软硬件系统验证**
- 加速工程实现

算法的工程化需要快速基于硬件平台迭代

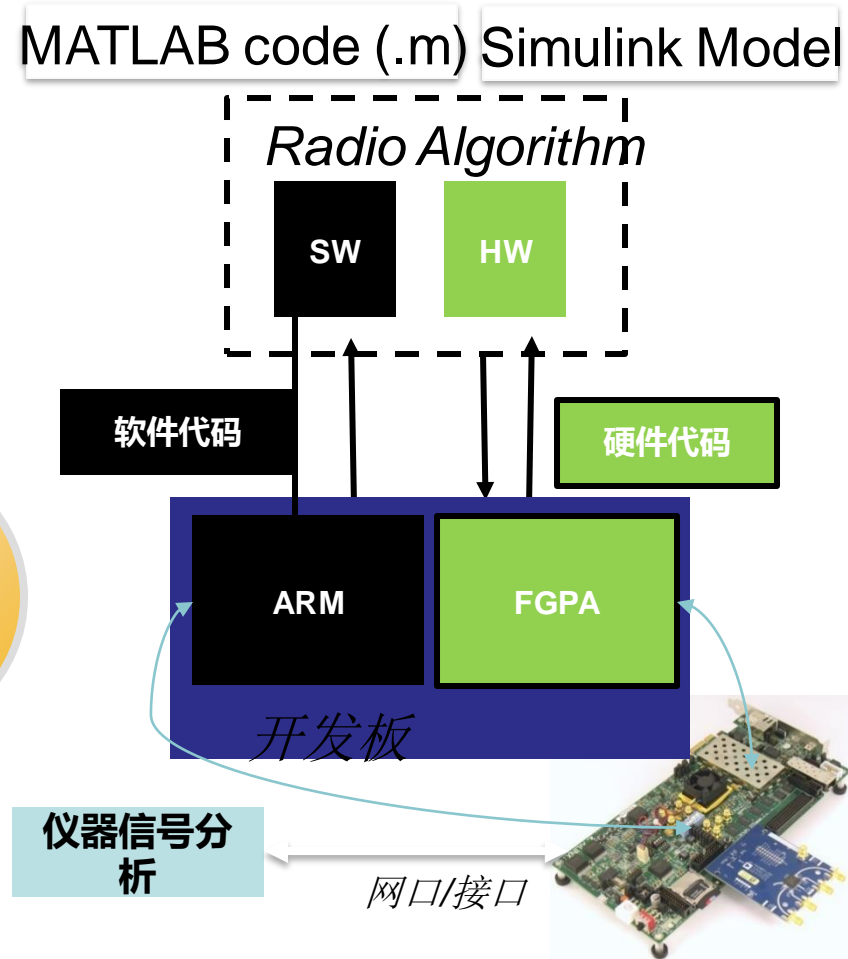
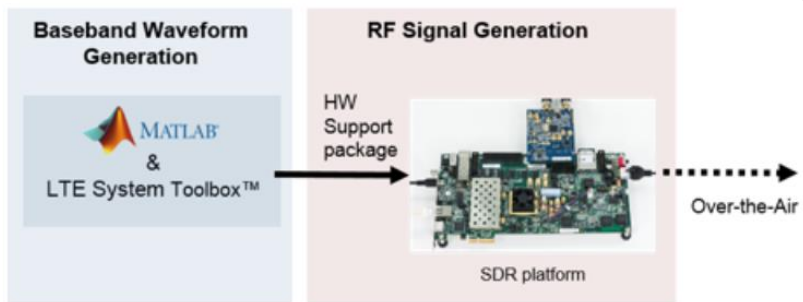
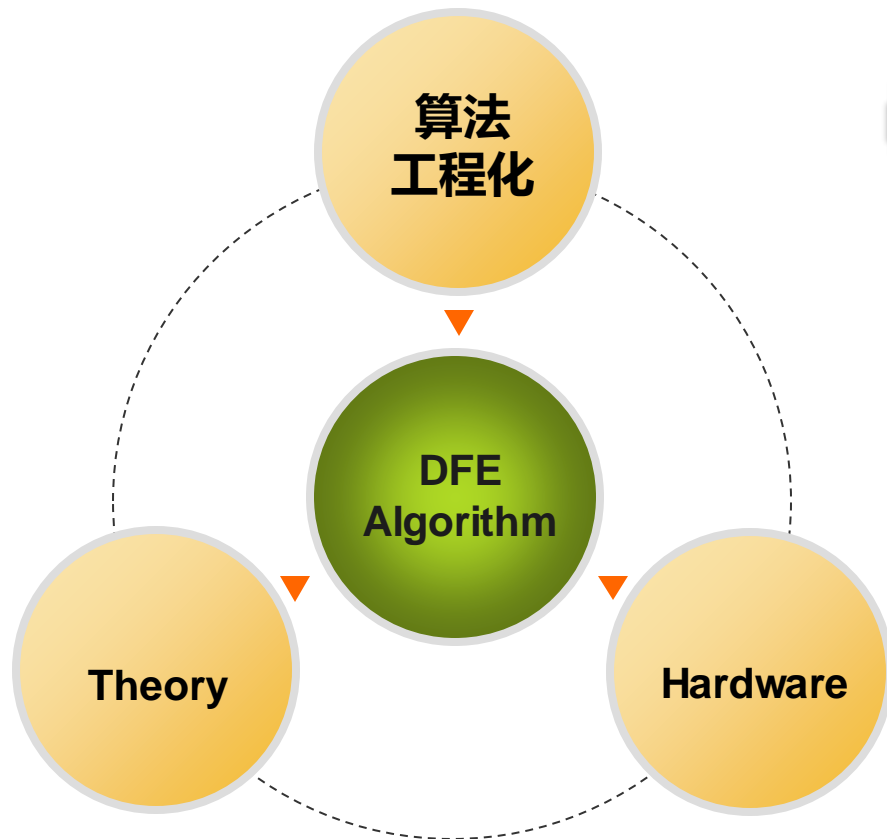

实例：软硬件联合开发平台

- 设计初期需要快速构建灵活/可调/高性能的硬件开发平台
- 采用Matlab+射频仪表是最高效的构建平台方式
- 通过软硬件联合仿真平台获得准确结果，指导后续算法与硬件的迭代优化

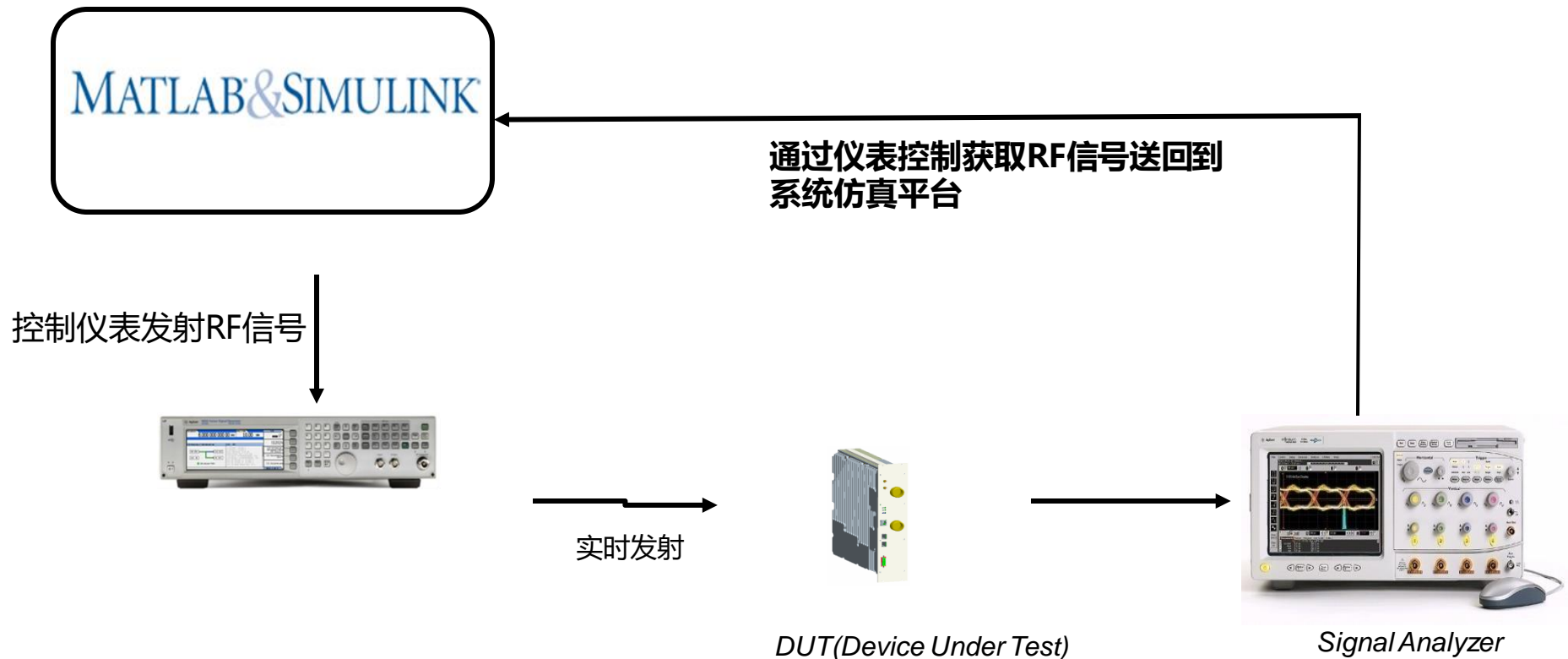

实例：自动化测试开发平台

- 设计中后期需要更高效率的软硬件联合验证平台
- 无缝对接业界成熟的FPGA/SDR平台，快速切换到全自动化测试开发平台，
- Matlab代码可继承开发，并借助HDL Coder等加速验证开发
- 测试结果自动化生成与分析

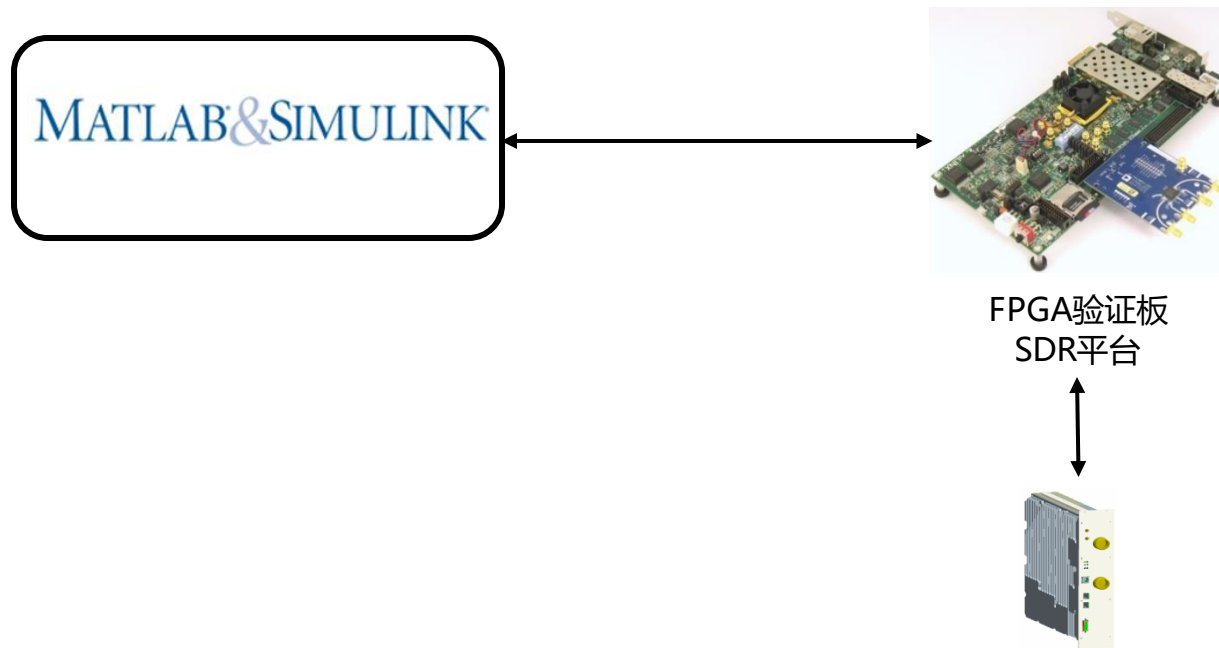

目录

- 无线通信网络的演进与挑战
- 模拟数字混合系统建模与分析
- 软硬件系统验证
- **加速工程实现**

自动化定点和自动代码生成

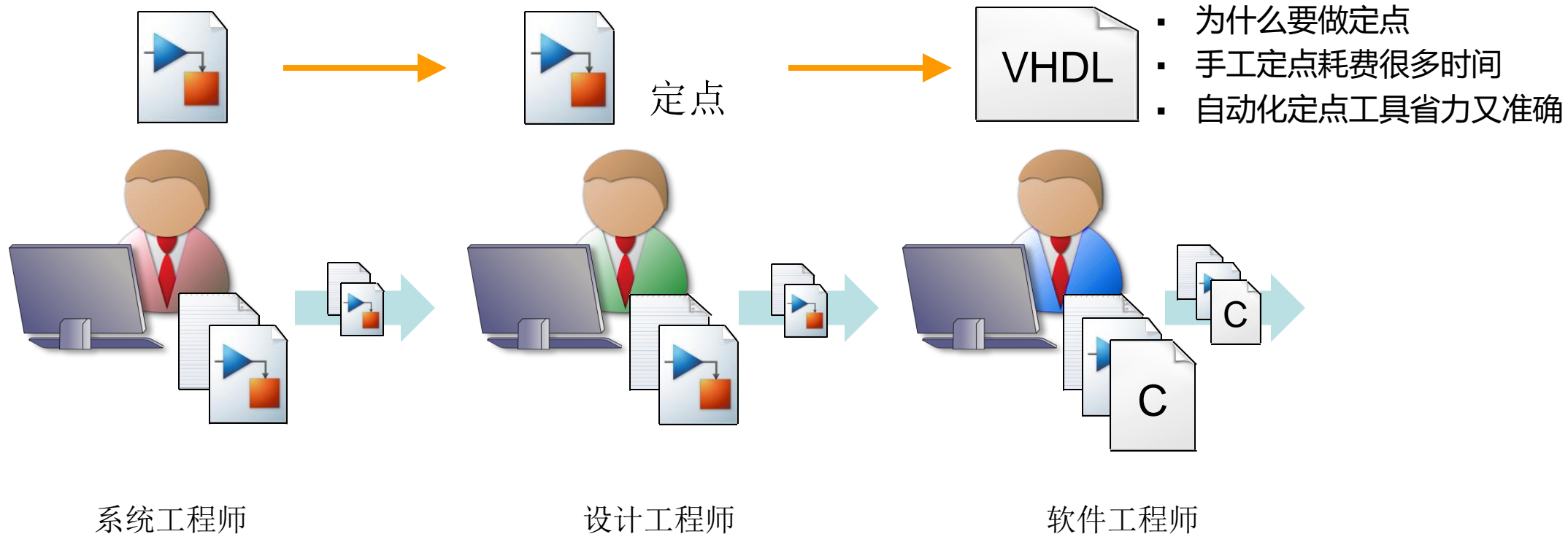

手写或自动生成代码

借助HDL Coder, RTL HDL和独立运行的Testbench都能自动生成

定点化算法设计到实现

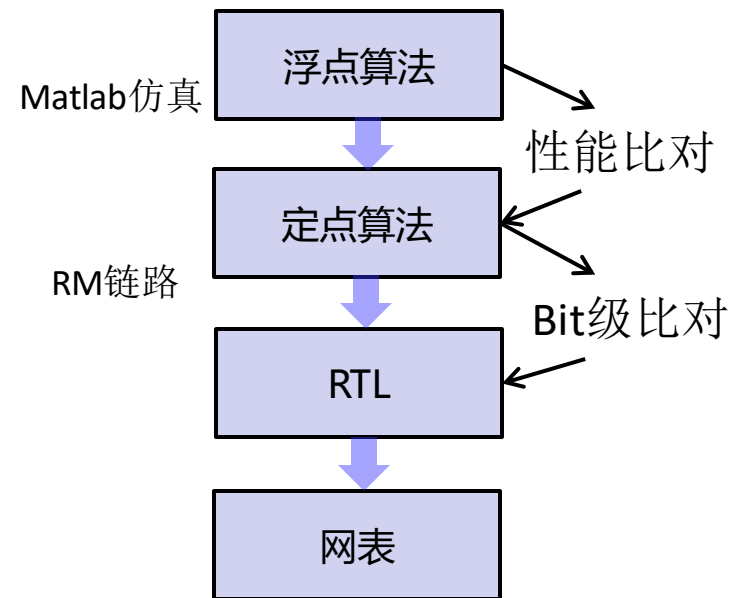

Matlab/Simulink

辅助工具

Simulink转C自动化工具

基于Matlab/Simulink链路快速实现定点化，自动转化为基于C的RM参考链路

- 自动修改C代码，使其输入、输出及参数可修改
- 自动生成参数配置文件
- 自动编译生成可执行文件
- 自动执行验证用例

- 链路运行速度快
- 开发/变更方便
- 配置自动化
- 验证自动化
- 算法人员轻松上手
- 问题定位快捷

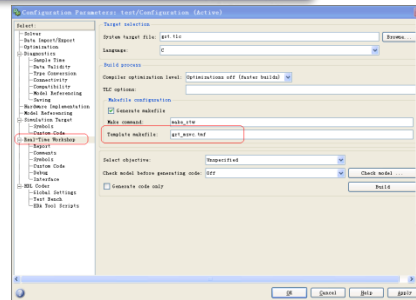
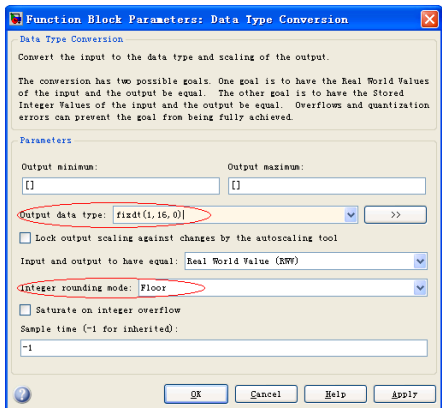

基于Matlab/Simulink实现端到端的算法工程化实现

算法/模块级FPGA在线验证HDL源代码

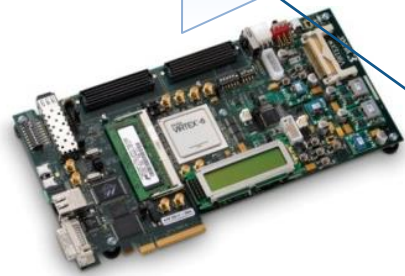
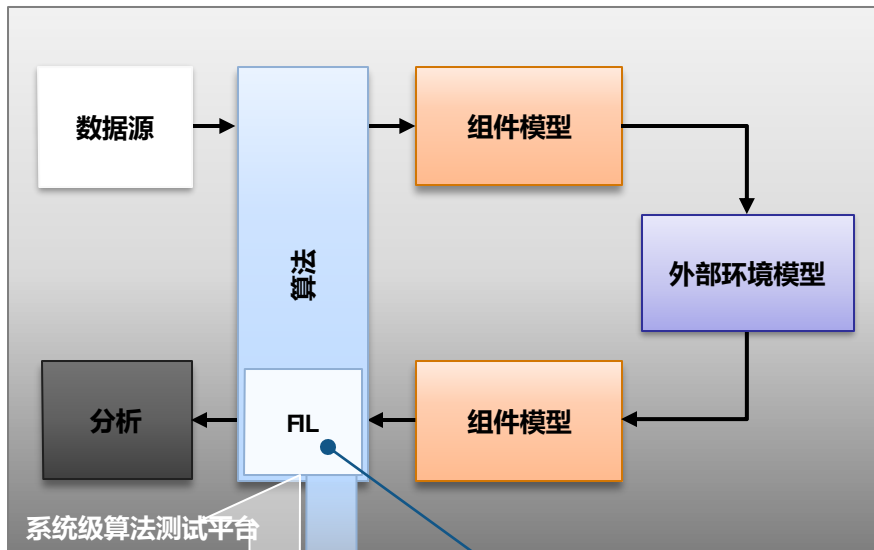

filWizard
(HDL Verifier),
HDL Workflow Advisor
(HDL Coder)
HDL Verifier

使用FPGA开发板的FIL仿真

重用已经在MATLAB/Simulink中搭建好的测试平台

HDL代码在FPGA中运行

灵活的HDL代码源

手写或自动生成代码

总结与展望

- **算法设计到工程化有较完善的工具链**
 - 强化系统模数混合设计：DPD
 - 软硬件系统验证：自动化验证平台，节约时间。
 - 需要与研发流程逐步融合，加速从算法到工程实现
- **高效率软硬件原型验证**
 - 快速完成定点化设计和比对
 - 自动生成代码，快速进行样机验证
- **对业界的工具有较好的支撑**
 - 业界及学术界模块进展快速集成

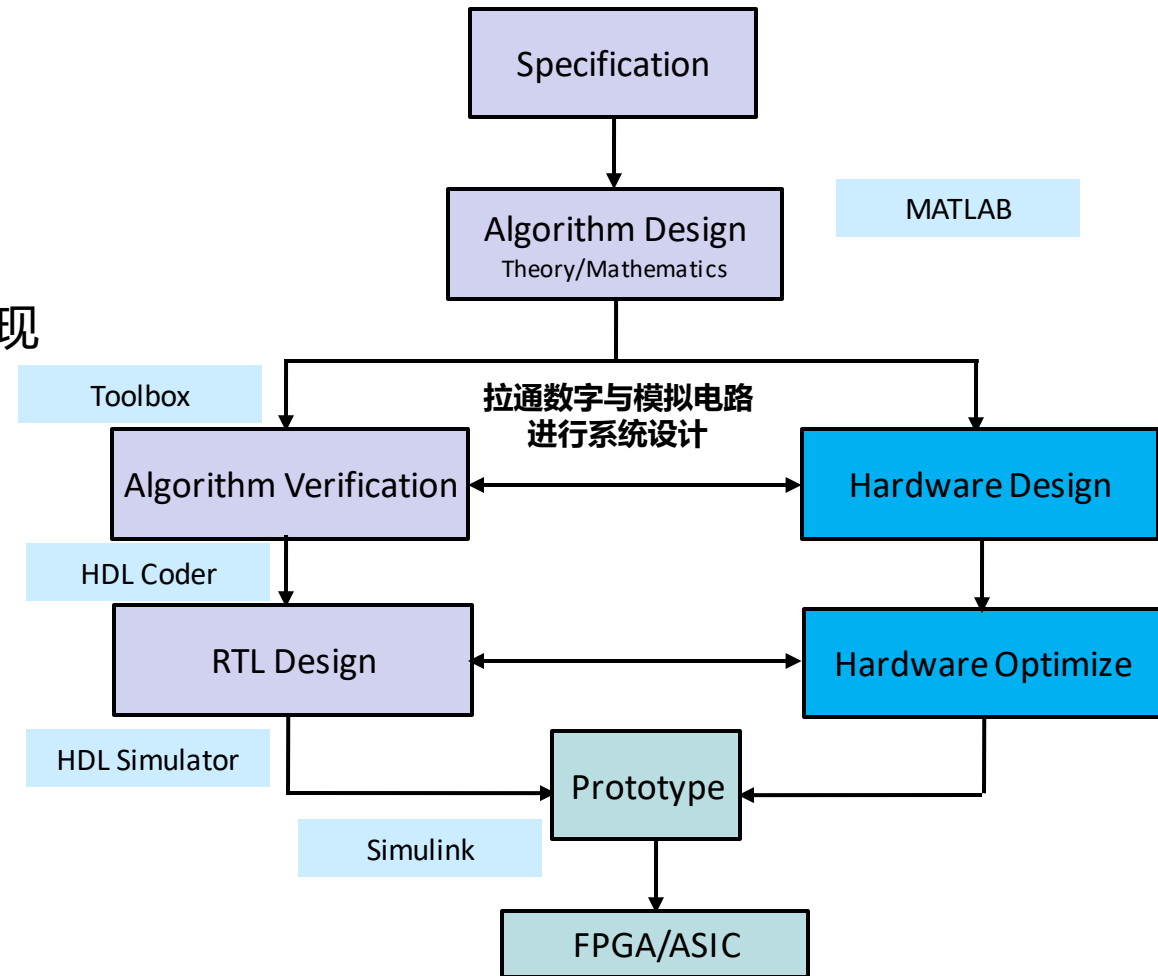

Thank you

www.huawei.com

Copyright © Huawei Technologies Co., Ltd. 2012. All rights reserved.

No part of this document may be reproduced or transmitted in any form or by any means without prior written consent of Huawei Technologies Co., Ltd.

NO WARRANTY

The information in this document may contain predictive statements including, without limitation, statements regarding the future financial and operating results, future product portfolio, new technology, etc. There are a number of factors that could cause actual results and developments to differ materially from those expressed or implied in the predictive statements. Therefore, such information is provided for reference purpose only and constitutes neither an offer nor an acceptance. Huawei may change the information at any time without notice.